



Food Preparation Machines  
Made in Sweden

Vegetable Preparation Machine

## RG-250 Vegetable Preparation Machine

- Slices, dices, shreds, grates, makes julienne and potato chips/French fries.
- Processes fruit, vegetables, dry bread, cheese, nuts, mushrooms, etc.
- Robust design made for commercial use and long life.
- High capacity. Processes up to 800 portions/day and 8 kg/minute.



# RG-250



### Ergonomics in all stages

The leaning design means that the feed cylinder is always positioned at the right angle – the machine is easy to top up. Using HALLDE Power Link you get a leverage effect from the pusher plate. The result is that you need almost 50 percent less manual power. For a better working posture, the pusher plate has a looped designed handle, HALLDE ErgoLoop, which means you can work with both your left and right hands. We recommend our vertically adjustable machine table to ensure you always work at the right height when using the machine.



### Safe and quick top ups

Thanks to the automatic start and stop function the machine stops as soon as the pusher plate is swung aside. When it is swung back the machine restarts and you can continue working. The RG-250 also has a full moon cylinder that can hold larger quantities and whole products. Features like these are a clear advantage, particularly when larger volumes are involved.

### Double safety against unprotected blades

If the feed cylinder is removed the power is cut. Thanks to this double security there is no risk of the machine starting with an unprotected blade.

### Developed for the best hygiene

The RG-250 is manufactured solely from hygiene certified material. The machine has smooth surfaces, rounded edges and has no unnecessary recesses where food might penetrate and get stuck.

### Easy cleaning

For quick cleaning all loose parts are simple to remove for easy rinsing of the machine. The pusher plate and feed cylinder are removable and can be cleaned under running water.

### Only the best material

Machine base, feed cylinder and pusher plate are all made of robust metal. Only top quality stainless steel is used to manufacture the cutting tool knife blades.

### Lightweight and easy to move

The relatively small size of the machine gives several advantages. It doesn't take up a lot of space in the kitchen. And it is easy to move, something which is helped by the generously sized handle on the back.



### Highest possible reliability

The powerful motor has a high starting and running torque and powers the direct-driven cutting tool. No belts or intermediate connections. The power from the motor goes via a maintenance free gear drive. This makes the RG-250 an exceptionally reliable machine – irrespective of the products you are preparing.

### Cutting tools with complete register

Our wide range of cutting tools means the RG-250 can handle every conceivable task. You choose the cutting tool you need to make you even more efficient in the kitchen. The RG-250 slices, dices, shreds, grates, makes juliennes and crimping slices – everything from firm to soft products. The blades and grating plates are replaceable. As a result you do not need to buy new cutting tools.



### Always perfect cutting results

The rotation speed of the cutting tools is optimised for cutting fine and even slices as efficiently as possible. The blades are purposely sharpened to avoid inertia or the edge breaking off.



### RG-250 accessories



Machine Table



Container Trolley



Wall Rack



Knife Guard



Brush

# Top quality cutting tools for any cut and optimal results



## Standard Slicer

6, 8, 10, 20 mm.

- Slices firm products such as root vegetables.



- Dices in combination with a suitable dicing grid.



## Fine Cut Slicer

0.5, 1, 1.5, 2, 3, 4, 5, 6, 7, 10, 15 mm.

- Slices firm and soft products, such as root vegetables, bell pepper, onion, leek, cucumber, tomato, apple, citrus fruit, bananas, mushrooms, etc.



- Shreds lettuce and cabbage.
- Chops onions in combination with dicing grid.
- Dices in combination with suitable dicing grid.



## Crimping Slicer

4-5 mm.

- For ripple slicing of beetroot, cucumber, carrots, etc.



## Dicing Cutter

12.5 mm.

- Dices root vegetables, potatoes, cabbage in combination with dicing grid.



## Julienne Cutter

2x2, 2.5x2.5, 4.5x4.5, 6x6, 8x8, 10x10 mm.

- Makes julienne potatoes and carrots for soups, cucumber for salads, etc.



- Julienne potatoes to curved French fries.

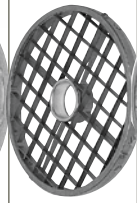

## Dicing Grid

6.25x6.25, 7.5x7.5, 10x10, 12.5x12.5, 15x15, 20x20 mm.

- Dices root vegetables, fruit, potatoes, cabbage, swedes, carrots, cucumbers, apples, etc. in combination with a suitable standard slicer or fine cut slicer.



## French Fry Grid

10 mm.

- Cuts potatoes to straight French Fries in combination with a fine cut slicer.

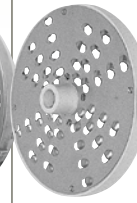

## Grater/Shredder

1.5, 2, 3, 4.5, 6, 8, 10 mm.

- Grates carrots and cabbage for raw salad.
- Grates nut, almonds and dry bread.



- Grates cheese for pizza and gratin.
- Shreds cabbage/white cabbage.

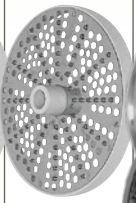

## Fine Grater Extra Fine Grater Hard Cheese Grater

- Grates root vegetables, dry bread, cheese etc.
- Fine Grater grates raw potatoes for potato pancakes.



- Extra Fine Grater grates radish, dry bread, etc.
- Hard Cheese Grater is perfect for cheese such as parmesan.



## Soft Dicing

8, 10, 12, 15 mm.

- Combination to dice soft products like tomatoes, onion, pepper, bananas, kiwi, strawberries etc.





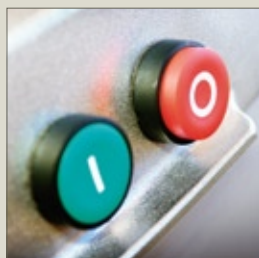
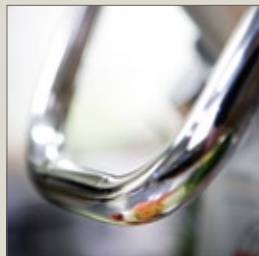

## RG-250 Vegetable Preparation Machine

- Large full moon feed cylinder that can take most items whole.
- Direct driven cutting tools from a strong heavy duty motor with planetary gear transmission.
- “HALLDE PowerLink” provide a leverage effect on the pusher plate which reduces the manual pressure needed to about half.
- “HALLDE ErgoLoop” enables the user to use both hands when operating the machine.
- Leaning design and support wall for easy piling of tomatoes, onions etc. for oriented slicing.

### Machine

- Motor: 0.55 kW. One-speed. 100 V, single phase, 50-60 Hz. 110-120 V, single phase, 60 Hz. 220 V, single phase, 50 Hz. 230-240 V, single phase, 50 Hz. 230 V, three phase, 50 Hz. 400 V, three phase, 50 Hz. 440 V, three phase, 60 Hz.
- Transmission: Planetary gearing.
- Safety system: Two safety switches.
- Degree of protection machine: IP44.
- Degree of protection push buttons: IP65.
- Power supply socket: Earthed, single phase, 10 A alternatively earthed, three phase, 16 A.
- Fuse: 10 A, delayed action fuse.
- Sound level LpA (EN31201): 72 dBA.
- Magnetic field: Less than 0.5 microtesla.

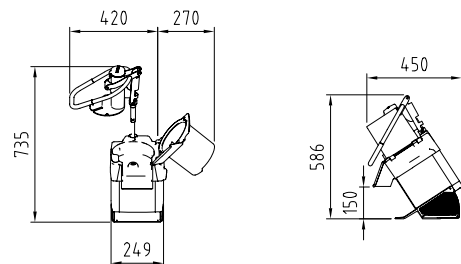
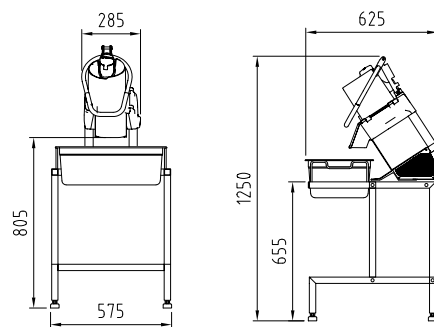

### Materials

- Machine housing: Anodized or polished aluminium alloy.
- Cutting tool discs: Aluminium alloy.
- Cutting tool knife blades: Stainless knife steel.
- Machine table: Stainless steel.
- Container: Polycarbonate.

### Feeder

- Cylindrical feeder. Volume 4 litre. Height 180 mm. Diameter 170 mm. One fixed internal support wall 55 mm wide.
- Feed tube with internal diameter 56 mm.
- Pusher plate with “HALLDE ErgoLoop” handle and “HALLDE PowerLink” lever system.

### Cutting tools

- Diameter: 185 mm.
- Speed: 350 rpm (50 Hz), 420 rpm (60 Hz).

### Type of preparation

- Slices, dices, shreds, grates, makes julienne, French fries and crimping slices.
- Processes fruit, vegetables, dry bread, cheese, nuts, mushrooms, etc.

### Users

- For restaurants, pizzerias, salad bars, schools, hospitals, fast food counters, ships, catering kitchens, etc.

### Net weights

- Machine: 21kg.
- Cutting plates: 0.5 kg.

### Standards

- EU Directive 98/37/EEC, LVD 73/23 EEC, EMC 89/336/EEC. • NSF/ANSI Standard 8.



Food Preparation Machines  
Made in Sweden

AB Hallde Maskiner P.O. Box 1165 SE-164 26 Kista Sweden

• Phone: +46 8 587 730 00 • Fax: +46 8 587 730 30 • www.hallde.com • info@hallde.com