

## GRILL STATIONS

**WA DEALER**  
**PRACTICAL PRODUCTS PTY LTD**

PH: 08 9302 1299  
51 Paramount Dr Wangara WA 6065  
sales@practicalproducts.com.au  
www.practicalproducts.com.au



*Multi-functional Grilling*





## Roband Grill Stations

The modern, stylish Roband Grill Station is available in six or eight slice size models.

The Roband range sets the benchmark for commercial contact grills. The versatile unit rapidly toasts sandwiches, paninis and focaccias, in addition to producing beautifully seared and grilled tender meat, poultry and fish. Featuring elements embedded directly into smooth, high pressure die-cast aluminium plates, the cooking surface produces an even, extremely efficient heat transfer ensuring food is cooked rapidly with even colouration.

The Roband Grill Station truly is a must-have for cafés, restaurants, takeaways, sandwich shops or anywhere that toasting and / or grilling is required.





## Grill Stations



### Features

- Six or eight sandwich capacity
- Quality high pressure die-cast aluminium cooking plates with cast-in elements for efficient, directional and effective heat transfer
- Precise thermostat for controlling cooking temperature
- Even temperature distribution across each plate and between the top and bottom plates
- Ability to switch between top and bottom plate operation or bottom plate only operation
- A counter-balanced top plate and an arched handle makes operating the Grill Station easy
- Easy one-handed loading and unloading of food with the top plate capable of staying partially open at an approximate 45° angle
- Food quality and appearance is protected from compression by the counter balanced and self levelling top plate
- Plate spacers are available separately for very thin contents
- High splash guard with top plate always positioned over bottom plate ensuring grease and crumbs fall onto bottom plate
- A front positioned grease collection box collects grease and crumbs and is well-positioned for easy removal and cleaning
- Small counter space requirement due to the elimination of a cumbersome back cable
- Angled control panel for clear visibility of settings
- 5 minute timer with warning bell
- Includes one premium spatula
- Optional ribbed top plate and / or non-stick coating
- Optional non-stick Roband Grill Sheet & retainer clip keeps the plates clean, prevents food sticking and is removable, cleanable & replaceable
- Optional side draining grease channel for high volume waste (model GC6 or GC8)



## The Range



GSA610S  
6 slice, smooth plates



GSA610R  
6 slice, ribbed top plate



GSA810S / GSA815S  
8 slice, smooth plates



GSA810R / GSA815R  
8 slice, ribbed top plate

## Non-stick options



Non-stick coated  
plates shown on  
GSA815ST



Roband Grill Sheet with  
clip shown on GSA610S  
(PGS605 & RC6)

All Roband Grill Stations are available with non-stick coated plates or the optional Roband Grill Sheet with clip.



## Specifications

	MODEL	SLICES No.	PLATE COATING	TOP PLATE	POWER Watts	CURRENT Amps	DIMENSIONS w x d x h (mm)	BOTTOM PLATE DIMENSIONS w x d (mm)
WORLDWIDE	GSA610S	6	NIL	SMOOTH	2200	9.6	435 x 490 x 220	375 x 275
	GSA610R	6	NIL	RIBBED	2200	9.6	435 x 490 x 220	375 x 275
	GSA610ST	6	NON-STICK	SMOOTH	2200	9.6	435 x 490 x 220	375 x 275
	GSA610RT	6	NON-STICK	RIBBED	2200	9.6	435 x 490 x 220	375 x 275
AUSTRALIA ONLY	GSA810S	8	NIL	SMOOTH	2300	10.0	560 x 490 x 220	500 x 275
	GSA810R	8	NIL	RIBBED	2300	10.0	560 x 490 x 220	500 x 275
	GSA810ST	8	NON-STICK	SMOOTH	2300	10.0	560 x 490 x 220	500 x 275
	GSA810RT	8	NON-STICK	RIBBED	2300	10.0	560 x 490 x 220	500 x 275
WORLDWIDE	GSA815S	8	NIL	SMOOTH	2990	13.0	560 x 490 x 220	500 x 275
	GSA815R	8	NIL	RIBBED	2990	13.0	560 x 490 x 220	500 x 275
	GSA815ST	8	NON-STICK	SMOOTH	2990	13.0	560 x 490 x 220	500 x 275
	GSA815RT	8	NON-STICK	RIBBED	2990	13.0	560 x 490 x 220	500 x 275

Note: All bottom plates are smooth. Timer does not over-ride or control thermostat. Maximum height when top fully open is 580 mm.

## Grill Station Accessories Description

- Retainer Clip & Grill Sheet - these are used to keep the Grill Station plates clean during use. They are easily removed for washing. The sheet is also non-stick preventing the food from sticking to the plates.
- Side Draining Grease Channel - this is designed to handle high volume of grease from cooked food. The Grease Channel drains into a collection vessel such as a small steam table pan.
- Rear Stand - the Rear Stand is designed to raise the Grill Station rear so that grease and crumbs drain and collect in the forward positioned grease box.
- Plate Spacer - various sizes are available and these are designed to ensure a consistent height is maintained between the top and bottom plates during operation. These are ideally suited to preparation of delicate products such as croissants.
- Aluminium Grill Pattern Plates - Designed to sit between the Grill Station smooth plates and Grill Sheet with Clip, the Aluminium Grill Pattern Plates produce a crosshatched char grill style pattern on the food being produced.

## Accessories

SUITS GRILL STATION MODELS	SHEET RETAINER CLIP MODEL NUMBER	ROBAND GRILL SHEET (PTFE) (NON-STICK) MODEL NUMBER	SIDE DRAINING GREASE CHANNEL	PREMIUM SPATULA (ADDITIONAL)
GSA610	RC6	PGS605 (5 pack QTY) PGS610 (10 pack QTY)	GC6	SP12 (12 pack)
GSA810 & GSA815	RC8	PGS805 (5 pack QTY) PGS810 (10 pack QTY)	GC8	SP12 (12 pack)

## Dimensions

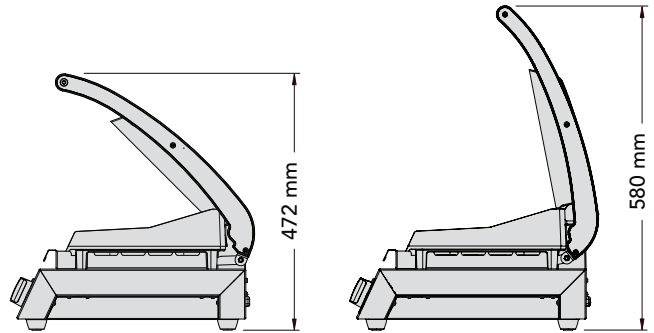
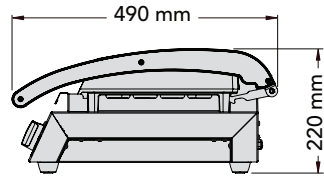
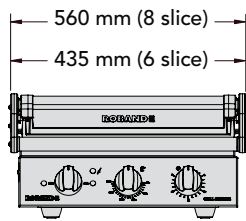

### Optional removable Grill Sheet with Retainer Clip

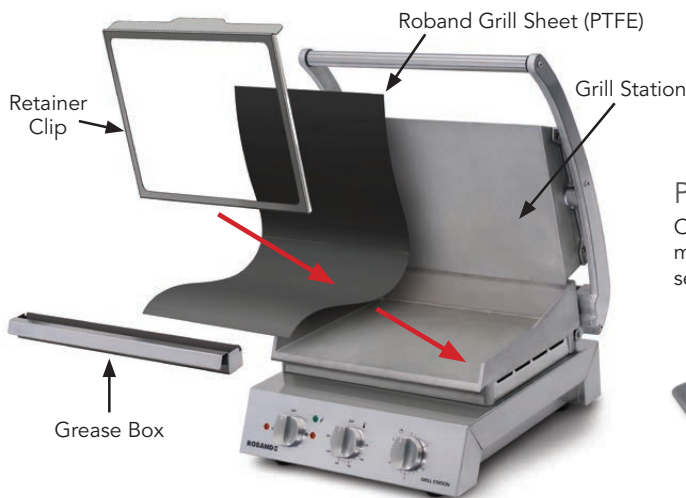

**Premium Spatula**  
One is included with each machine. Also available separately.



### Side Draining Grease Channel Pan not included



### Aluminium Grill Pattern Plate

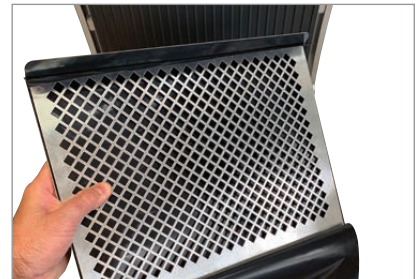

Showing easy installation on a Grill Station top plate



Showing easy installation on a Grill Station bottom plate



Spacers available in various sizes to suit

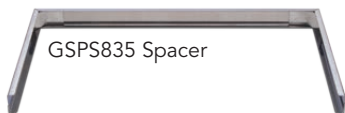

GSPS835 Spacer

GSPS835 Spacer inside a GSA810S

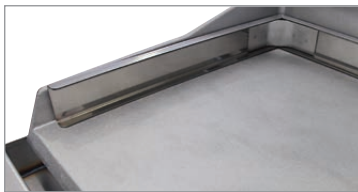

Rear Stand

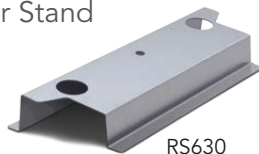

RS630

GSA810S sitting on a rear stand RS830



#### REAR STAND

RS630

RS830

#### PLATE SPACER

GSPS625  
GSPS635  
GSPS645

GSPS825  
GSPS835  
GSPS845

#### ALUMINIUM GRILL PATTERN PLATE

GS6-P1  
(a set of 2)

GS8-P1  
(a set of 2)





**Roband Australia Pty Ltd**  
1 Inman Road,  
Cromer, NSW 2099  
Australia  
Tel: +61 2 9971 1788  
Fax: +61 2 9971 1336  
Email: sales@roband.com.au

**Roband (Europe) Ltd**  
Haygarth Park, Blaenau Ffestiniog  
Gwynedd, North Wales  
LL41 3PF, UK  
Tel: +44 (0) 1766 830 456  
Email: info@robandeurope.com

All standard Roband Grill Stations are designed to run at 220-240V per phase, 50Hz.

All dimensions are nominal only. All information contained in this brochure should serve as a guide only and is subject to change without notice due to constant research and development.

© 2019 Roband Australia Pty. Ltd. ACN 003 049 063 ABN 34 864 327 105

® is a registered trademark of Roband Australia Pty. Ltd.



**WA DEALER**  
**PRACTICAL PRODUCTS PTY LTD**

PH: 08 9302 1299  
51 Paramount Dr Wangara WA 6065  
sales@practicalproducts.com.au  
www.practicalproducts.com.au