

Viking 4G Electric Static Jacketed Kettle

Viking 4G 100E (4224106)

Standard Features

- 100 litre capacity
- Electric heated version
- Elevated control pillar with selected features
- Electromechanical controls
- Stepless temperature control
- Electric tilting – tilting height 600mm
- Auto tilt-back
- Measuring stick
- Retractable handshower
- Strainer plate
- Stainless steel construction
- Unit shown includes free standing floor kit - other options available

Please refer to Moffat price list for options and accessories

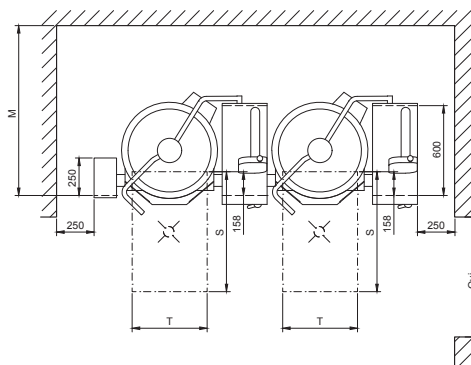
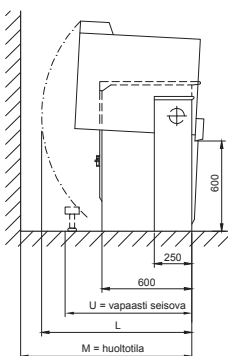
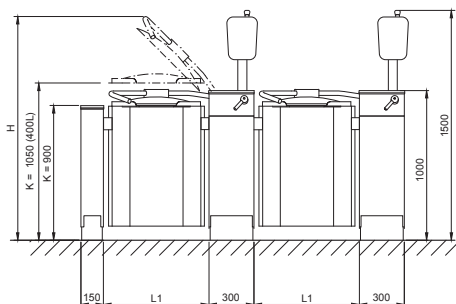

Technical Data

Net Volume 100 L
Spare Volume 11 L
Gross Volume 111 L

Dimensions

Width 1154mm
Height 1500mm
Depth 725mm

Connections

Water Cold ø15mm
Hot ø10mm

Electrical Power 16 kW
Voltage 400-415V,
3P+N+E 50/60Hz
AMP 25A

Total Heat 16 kW
Load Latent 0.8 kW,
Sensible 3.4 kW

Waste By kitchen
contractor
Nett Weight 210 kg

Model	L1 mm	H mm	L mm	M mm	U mm	T mm	Door mm
100E	704	1745	1010	1235	890	500	800



WA DEALER
PRACTICAL PRODUCTS PTY LTD

PH: 08 9302 1299
51 Paramount Dr Wangara WA 6065
sales@practicalproducts.com.au
www.practicalproducts.com.au