



Thanks to a continuous and regular flow, the water is distributed on a refrigerated surface designed to increase ice production. Three different sizes are available **FULL DICE, HALF DICE** and **LARGE DICE**

High production modular ice maker.
Up to 465kg production per 24/hr of dice cube.
Head only, stainless steel cabinet.
Complete with water & drain hoses.
15 AMPS, single phase power supply.



ICE PRODUCTION

Air Cooled Unit

Air Temp.		Water Temperature			
		32°	21°	15°	10°
°C		32°	21°	15°	10°
°F		90°	70°	60°	50°
10°		415	440	453	465
50°		915	970	999	1025
21°		385	410	425	431
70°		849	904	936	950
32°		307	341	353	364
90°		677	752	778	802
38°		276	307	316	326
100°		608	677	696	719

Water Cooled Unit

Air Temp.		Water Temperature			
		32°	21°	15°	10°
°C		32°	21°	15°	10°
°F		90°	70°	60°	50°
10°		345	385	400	415
50°		761	849	882	915
21°		335	373	390	405
70°		739	822	860	893
32°		320	360	373	385
90°		705	794	822	849
38°		305	345	360	370
100°		672	761	794	816

CUBE TYPE

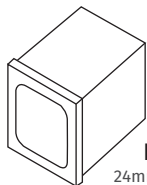

10g
FULL CUBE
24mm x 22mm x 22mm

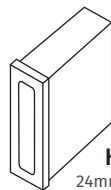

6g
HALF CUBE
24mm x 10mm x 29mm

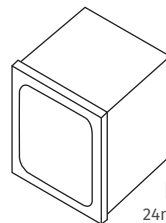

17g
LARGE CUBE
24mm x 29mm x 29mm

Solid ice cube, suitable for quick drink cooling, available in three different sizes, **FULL DICE (M models)**, **HALF DICE (MH models)** and **LARGE DICE (ML models)**, can be used in various applications: ice buckets, whisky on the rocks and cocktails.

CONTROL PANEL

	Power
	Operating
	Bin Full / Washing
	Alarm
	High Pressure Alarm
	Reset Button / Washing

SUGGESTED STORAGE BIN



BH122+KBT25
Stainless steel
storage bin.
406kg capacity.











DIMENSIONS

W x D x H (mm)
760 x 620 x 725

OPERATING REQUIREMENTS

Rejected Heat	6581 W
Air Volume	1180 m ³ /h
220-240/50/1	R404a GWP=3922
MIN	MAX
10°C (50°F)	40°C (104°F)
5°C (41°F)	35°C (95°F)
- 10 %	+ 10 %
1 Bar (14 psi)	5 Bar (70 psi)

SPECIFICATIONS

											
	cond	comp. W	ABS. W	Fuse	kWh/100kg	L / hr	kg	lbs	kg	lbs	Ton CO2 equiv.
M502 A		6274	2550	20	13.47	20.2	98	216	116	256	6.28
M502 W		6274	2020	20	10.6	208	98	216	116	256	4.71

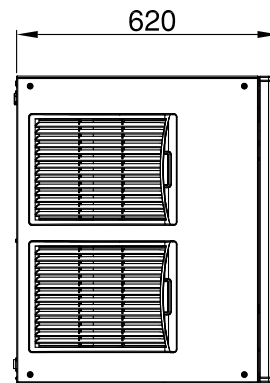
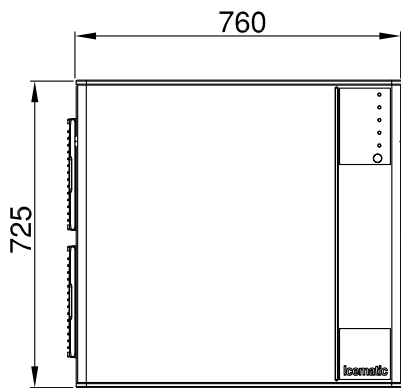

AIR COOLED

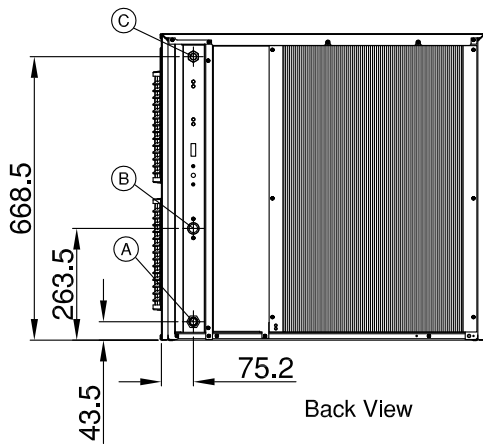

WATER COOLED

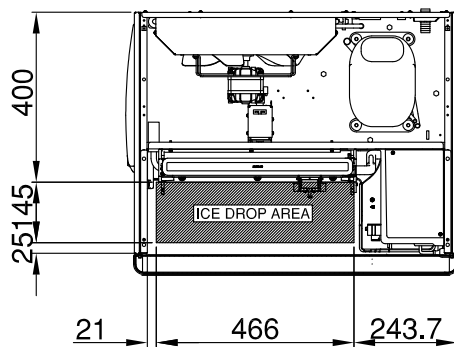
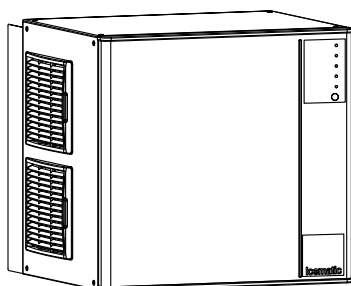
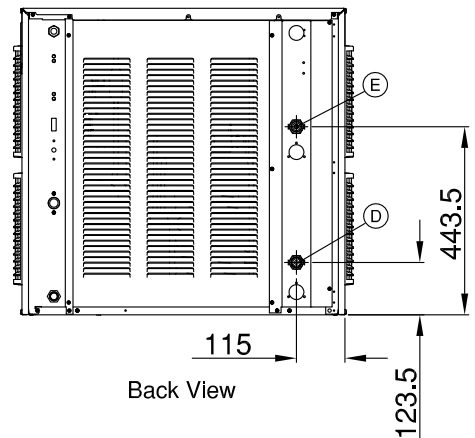

- (A) Water drain 20mm diam.
- (B) Potable water inlet 3/4" gas
- (C) Electrical cable supply
- (D) Water cooled inlet 3/4" gas
- (E) Water cooled outlet 3/4" gas

WA DEALER
PRACTICAL PRODUCTS PTY LTD

PH: 08 9302 1299
51 Paramount Dr Wangara WA 6065
sales@practicalproducts.com.au
www.practicalproducts.com.au